

적용 도면 (Applied DRAW. No.)	
도면 번호 (DRAW. No.)	비 고 (Remarks)
1	
2	

MARK	DATE	DETAIL OF REVISION	CHECK	APP.
△				
△				

SCH-10-3

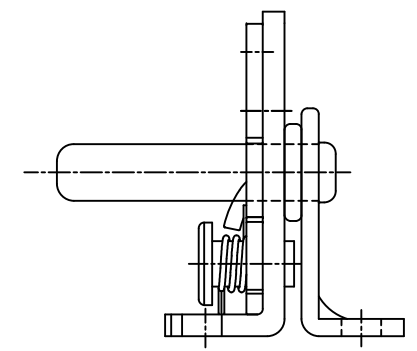
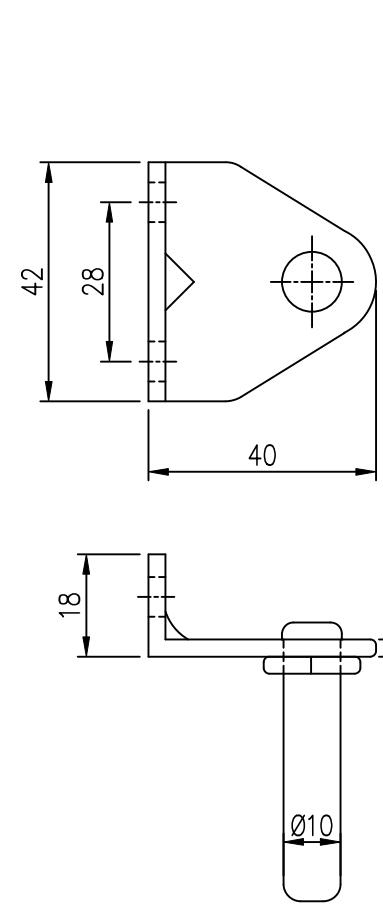
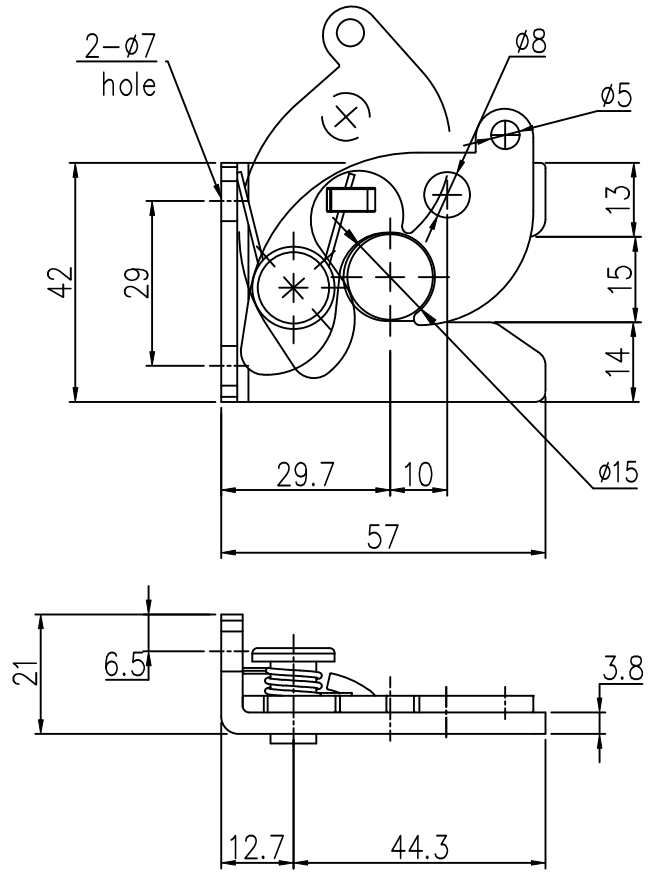

GENERAL TOLERANCE

DIVISION	GRADE	A LEVEL	B LEVEL	C LEVEL
1-4	<del>±0.05</del>	<del>±0.10</del>	<del>±0.25</del>	
4-6	<del>±0.07</del>	<del>±0.20</del>	<del>±0.35</del>	
16-63	<del>±0.10</del>	<del>±0.30</del>	<del>±0.50</del>	
63-250	<del>±0.18</del>	<del>±0.55</del>	<del>±0.90</del>	
250-500	<del>±0.30</del>	<del>±0.90</del>	<del>±1.50</del>	
500-1000	<del>±0.50</del>	<del>±1.50</del>	<del>±2.50</del>	

부 품 번 Part No.	번호 No.	명 칭 Part Name	갯수 Qt'y	재 질	비 고 Remarks
DRAWN	CHECKED	CHECKED	APPROVED	SCALE : 1 / 1	MODEL :
				UNIT : MM	TITLE :
			SIZE : A3	THIRD ANGLE PROJECTION	MODEL No.
			DATE :	DWG No.	