

적용 도면 (Applied DRAW. No.)	
도면 번호 (DRAW. No.)	비고 (Remarks)
1	
2	

MARK	DATE	DETAIL OF REVISION	CHECK	APP.
△				
△				

SM-4S

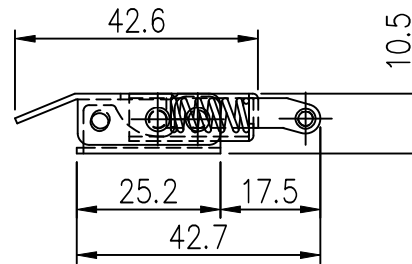
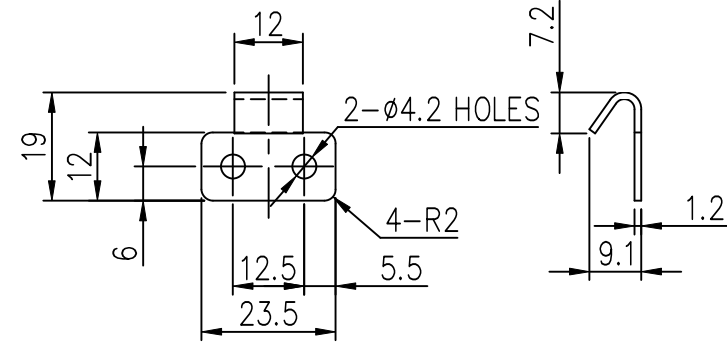
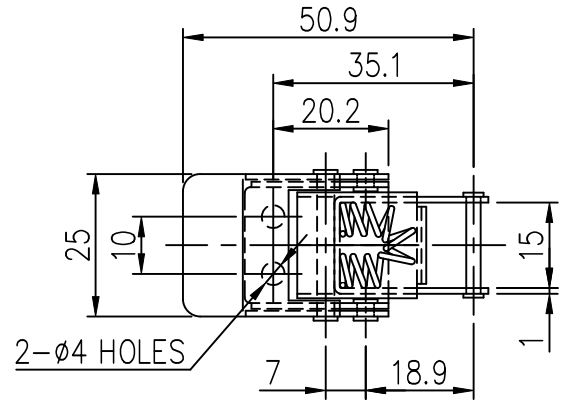

주 기

- 외관표면에 흠집이 생기지 않도록 취급주의
- 제품 조립시 작업자가 상해를 입지 않도록 날카로운 부위를 제거한다.
- 일반공차는 B등급을 적용한다.
- 기타 자세한 사항은 설계자와 협의한다.

GENERAL TOLERANCE

DIVISION	GRADE	A LEVEL	B LEVEL	C LEVEL
1-4		±0.05	±0.10	±0.25
4-6		±0.07	±0.20	±0.35
16-63		±0.10	±0.30	±0.50
63-250		±0.18	±0.55	±0.90
250-500		±0.30	±0.90	±1.50
500-1000		±0.50	±1.50	±2.50

부 품 번 Part No.		번호 No.	명 칭 Part Name		갯수 Qt'y	재 질 Material	비 고 Remarks
DRAWN	CHECKED	CHECKED	APPROVED	SCALE : 1/1	MODEL :		
				UNIT : MM	TITLE :		
				SIZE : A3	THIRD ANGLE PROJECTION	MODEL No.	
				DATE :	DWG No.		

